

Model # 21HN3KV110

2-way, internally piloted, normally closed solenoid valve, with assisted lift

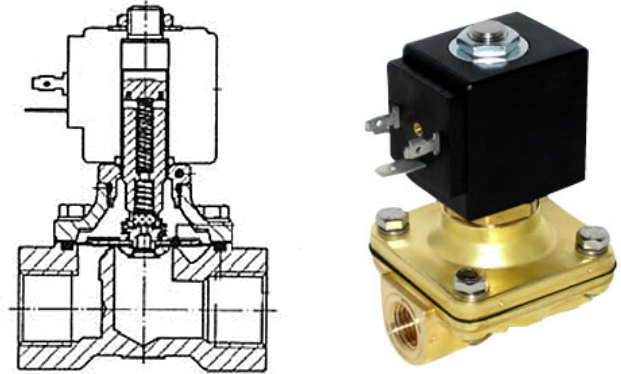

3/8" Pipe Size (Inch)	7/16" Orifice Size (Inch)	1.40 Flow Factor (CV)	14 Watt Rating (W)	0 Min. Pressure (PSI)	200/200 Max. Pressure (AC/DC)
FKM Sealing Material	14° - 280° F Temperature Range	Air, Inert gas, Water, Synthetic oils Medium Examples			

Materials of Construction

Body:	Brass
Armature Tube:	Stainless Steel 300
Fixed Core:	Stainless Steel 400
Plunger:	Stainless Steel 400
Spring:	Stainless Steel 300
Shading Ring:	Copper
Orifice:	Brass

Valve Dimensions

Valve Width(A):	1 31/32"
Valve Length(B):	2 7/32"
Valve Height(C):	3 1/2"
Coil Width(D):	2 1/16"
Coil Length(E):	2 5/32"
Coil Length(F):	2 5/8"

Electrical Connection

Rating:	NEMA 4
Strain Relief Connector:	Model 009
1/2" Conduit Connector:	Model 010
6 ft. Power Cord:	Model GRN100
Inrush VA:	43
Holding VA:	27

Spare Parts

Kit:	KTGHT3KOV11
------	--------------------

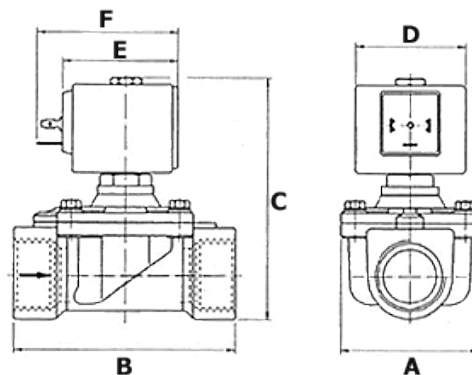

Note: Valve is pictured above with a sample coil, which may or may not reflect the exact specifications of this particular build.